

iCON



PX-T5A²

PX-T6A²

PX-T8A²





Pixels Series 5.5"/6.5"/8" Active Studio Monitor System

Owner's Manual



eN16549



 CAUTION 	
RISK OF ELECTRIC SHOCK DO NOT OPEN RISQUE DE CHOC ELECTRIQUE NE PAS OUVRIIR	
CAUTION: TO REDUCE THE RISK OF ELECTRIC SHOCK DO NOT REMOVE COVER (OR BACK) NO USER-SERVICEABLE PARTS INSIDE REFER SERVICING TO QUALIFIED PERSONNEL	
ATTENTION: POUR EVITER LES RISQUES DE CHOC ELECTRIQUE: NE PAS ENLEVER LE COUVERCLE. AUCUN ENTRETIEN DE PIECES INTERIEURES PAR L'USAGER. CONFIER L'ENTRETIEN AU PERSONNEL QUALIFIE. AVIS: POUR EVITER LES RISQUES D'INCENDIE OU D'ELECTROCUTION, N'EXPOSEZ PAS CET ARTICLE A LA PLUIE, OU A L'HUMIDITE	

The lightning flash with arrowhead symbol within an equilateral triangle is intended to alert the user to the presence of uninsulated dangerous voltage within the product's enclosure, that may be of sufficient magnitude to electric shock to persons. Le symbol clair avec point de flèche à l'intérieur d'un triangle équilatéral est utilisé pour alerter l'utilisateur de la présence à l'intérieur du coffret de voltage dangereux non isolé d'ampleur suffisante.

The exclamation point within an equilateral triangle is intended to alert the user of the presence of important operating and maintenance (servicing) instructions in the literature accompanying the appliance. Le point d'exclamation à l'intérieur d'un triangle équilatéral est employé pour alerter les utilisateurs de la présence d'instructions importantes pour le fonctionnement et l'entretien (service) dans le livret d'instruction accompagnant l'appareil.

Important Safety Instructions

1. Read this manual thoroughly before using this unit.
2. Keep this manual for future reference.
3. Take notice of and comply with all warnings included in the user's manual or indicated on the appliance.
4. Follow all instructions included in this manual.
5. Do not expose this unit to rain or moisture. Avoid having water or other liquids spilled on this unit.
6. When cleaning the cabinet or other parts of this appliance, use only a dry or slightly damp soft cloth.
7. Do not block any ventilation openings or interfere with the proper ventilation of this unit. Install in accordance with the manufacturer's instructions.
8. Do not use or store near any heat sources such as radiators, heat registers, stoves, or other heat-producing appliances.
9. Do not interfere with the safety purpose of the polarized or grounding-type plug. A polarized plug has two blades with one wider than the other. A grounding-type plug has two blades and a third grounding prong. These are designated for your safety. If the provided plug does not fit into your outlet, consult an electrician.
10. Protect the power cord from being walked on or otherwise damaged by items placed on or against them. Particular attention should be given to the plugs, receptacles, and the point where the cord exits the appliance.
11. To avoid the risk of electrical shock, do not touch any exposed wiring while the unit is in operation.
12. Only use attachments/accessories specified by the manufacturer.
13. Unplug this unit and all connected electrical equipment during lightning storms or when left unused a long period of time.
14. Refer all servicing to qualified service personnel. Servicing is required when the appliance has been damaged in any way or fails to operate normally.

WARNING: To reduce the risk of fire or electric shock, do not expose this unit to rain or moisture

Contents



Introduction	1
What's in the package	1
Register your ICON ProAudio product to your personal account	2
Features	3
Front Panel Layout	4
Rear Panel Layout	5
Setting Up your PX-T G2 Active Studio Monitor System	6-7
Background on the PX-T G2 Active Studio Monitor System	6
Positioning the PX-T G2	6
Speaker Orientation	7
Reflection	7
Connecting your PX-T G2 Active Studio Monitor System	8
PX-T G2 Quick Connections	8
Operating your PX-T G2 Active Studio Monitor System	9-10
PX-T G2 Control and Connectors Panels	9
Powering the PX-T G2	9
Things that go hum!	9
Front Panel Controls	9
The Rear Panel: The Ins and the Outs	10
Specifications	11
Services	12

Introduction

Thank you for purchasing the ICON PX-T series active studio monitor system. We sincerely trust this product will provide years of satisfactory service, but if anything is not to your complete satisfaction, we will endeavor to make things right.



In these pages, you'll find a detailed description of the features of the PX-T, step-by-step instructions for its setup and use, and full specifications.

Please register the product on our website at the below link www.iconproaudio.com/registration:

You'll also find a warranty card enclosed---please don't forget to fill it out and mail it so that you can receive online technical support at: www.iconproaudio.com. And so we can send you updated information about these and other ICON products in the future. As with most electronic devices, we strongly recommend you retain the original packaging. In the unlikely event the product must be returned for servicing, the original packaging (or reasonable equivalent) is required.

With proper care , your PX-T will operate without any trouble for many years. We recommend that you record your serial number in the space provided below for future reference.

What's in the package?

- PX-T5A² / PX-T6A² or PX-T8A² Active Studio Monitor System
- Users' Manual
- Power Cable
- "VasorbTM" x 4pcs.

Register your ICON ProAudio product to your personal account

1. Check serial number of your device

Please go to [http:// iconproaudio.com/registration](http://iconproaudio.com/registration) or scan the QR code below.



Input your device's serial number and the other information on the screen. Click "Submit".

A message will pop up showing your device information such as model name and its serial number - Click "Register this device to my account" or if you see any other message, please contact our after-sales service team

2. Log in to your personal account page for existing user or sign up for new user

Existing user: Please log into your personal user page by inputting your user name and password.

New user: Please click "Sign Up" and fill in all the information.

3. Download all useful materials

All your registered devices under your account will show on the page. Each product will be listed along with all its available files such as drivers, firmware, user manual in different languages and bundled software etc. for download.

Please make sure you have download the necessary files such as driver before you begin device installation.

Features

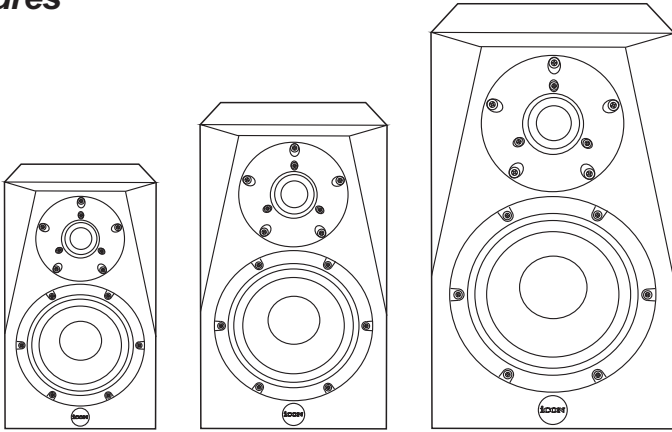

The ICON PX-T series Active Studio Monitor system provide a smooth response that is accurate and pleasant to listen to. Here are some of its main features:

- Compact high performance active studio monitor
- R-Type Transformer for super clean output
- Active 2-Way Monitor System with complex Active Crossover design
- High, Mid and Low range contour control
- High-Pass Filter - Flat, 60Hz & 80Hz selectable
- The ideal solution for near-field monitoring in any recording or broadcasting facility
- Designed for use in stereo as well as multichannel setups
- Tuned by top-skilled acoustic engineer's ear to fulfill any requirements in real recording studio environments
- ICON's "Vasorb™" monitor stands are included
- Build-in Bi-Amp power module for low and high frequency drivers
 - PX-T5A² : 60-watts on LF and 30-watts on HF
 - PX-T6A² : 80-watts on LF and 30-watts on HF
 - PX-T8A² : 100-watts on LF and 30-watts on HF

Mid/Woofers

- ICON 5"/6"8" polypropylene with paper dustcap
- Low loss SBR surround with low creep and long time reliability
- Progressive spider to achieve soft clipping and low distortion even under extreme load
- Dual magnet ferrite magnet system with extended height for superb bass reproduction
- Aluminum short circuiting ring
- Very rigid die-cast aluminum chassis with very open geometry for optimized air-flow to eliminate compression

Tweeter

- High-end 1" dome tweeter
- Soft fabric dome and surround with wide-dispersion optimized geometry
- Big surround to reduce distortion
- Low loss ferrofluid-free magnet system for open and detailed sound
- Robust and very rigid design
- Diffraction optimized smooth front baffle design
- Extended front baffle dimensions to eliminate any vibration or sound radiation from the enclosure

Front Panel Layout

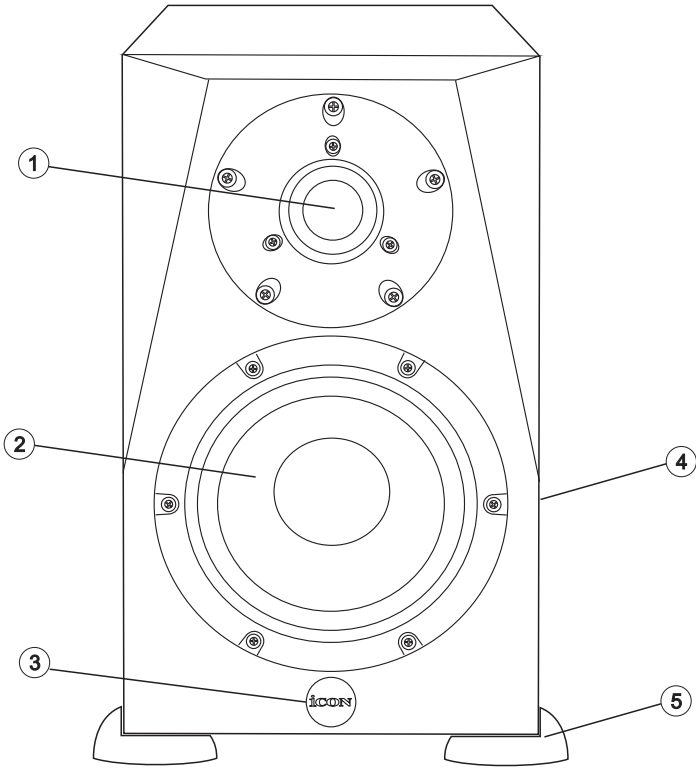

- ① **1" silk dome tweeter**
Smooth high frequency response produced from silk dome, neodymium magnet with ferrofluid plus heat sink cooling for high output
- ② **Low frequency driver**
Heavy duty extended range low frequency transducer.
- ③ **Power LED**
Orange LED glows when the unit is powered on and ready for operation.
- ④ **Finish**
Durable spray finish
- ⑤ **"Vasorb (TM)" monitor rubber feet**
iCON large rubber feet keep enclosure in place even at high sound pressure levels.

Rear Panel Layout

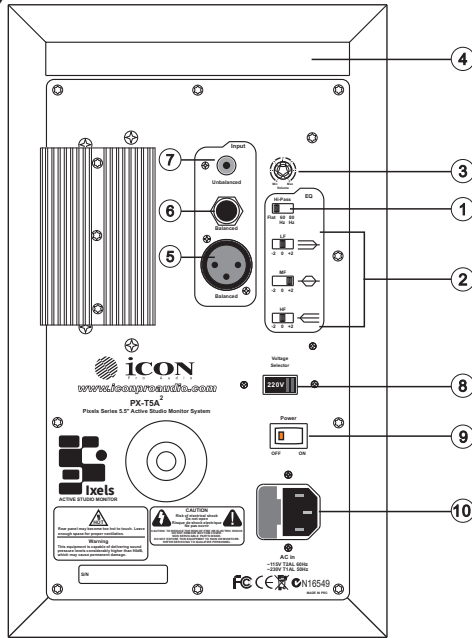

- ① **Hi-Pass filter control**
3-position switch used to adjust the Hi-Pass filter from Flat, 60Hz & 80Hz
- ② **Hi, Mid and Low range contour control**
3-position switch used to adjust the Hi, Midrange and Low response providing customized voicing from hi-fi to aggressive midrange.
- ③ **Volume**
Controls the amount of output level
- ④ **Tuned port**
Quiet port design offering linear extended low frequency response.
- ⑤ **XLR balanced input**
Balanced, line level input is connected here via standard XLR cable.
- ⑥ **1/4" TRS balanced input**
Balanced TRS (Tip, Ring, Sleeve) 1/4" plug used to connect balanced or unbalanced line level signals.
- ⑦ **RCA unbalanced input**
Used to connect signals from unbalanced, -10dBV devices.
- ⑧ **Voltage Selector**
110V / 220V input voltage selector
- ⑨ **Power Switch**
Turns the unit on/off.
- ⑩ **AC inlet**
Connect the supplied IEC power cable here.

Setting up your PX-T G2 Active Studio Monitor System

Background on the PX-T G2 Active Studio Monitor system

The PX-T G2 is a near field studio monitor featuring a custom design with 5.5", 6.5" or 8" copolymer. low frequency driver and a 1" silk tweeter employing a ferrofluid-cooled voice coil and neodymium magnet. The monitor's crossover has been carefully designed with high quality components insuring a linear frequency and phase response. The PX-T G2 enclosure is constructed from MDF. It has designed with tuned vent port that provides extended low-end response, and with a low turbulence design, the low frequency driver can move freely with minimal effect on the overall impedance. On the rear of the of the enclosure you'll find a variety of input connectors including XLR, 1/4" TRS balanced input and RCA unbalanced input. These inputs are connected to PX-T G2 internal Bi-Amp power module providing power to each PX-T G2 monitor speaker. You will also find the pre-amp controls, including Volume knob, used to adjust the overall level of the internal power amplifier, as well as the innovative Hi, Midrange and Low presence control. These controls allow the mix engineer to contour the Hi, Midrange and Low response of the monitor from a traditional hi-fi sound to flat and then through two levels of aggressive Hi, Midrange, Low response. The PX-T G2 has been designed to provide flat, accurate monitoring, and at the same time, to provide an adjustable response curve so that the sound of other popular nearfield monitors can be easily emulated.



Positioning the PX-T G2 monitor

Near field monitoring has become choice of many engineers in large and small studios because it minimizes the effect of room acoustics. By positioning the reference monitors in the near field (close to the listener), you can greatly reduce the effects of room acoustics.

The most important considerations when evaluating the effects of room acoustics are reflective surfaces that are around the monitoring area. These can include flat tablespots, glass mirrors, framed pictures, large open walls and even the surface of your mixing console. All reflecting sound will eventually reach the listening position, but since it is slightly delayed from the direct source, the result is random cancellation of some frequencies, or comb filtering. If possible, remove any and all reflective surfaces. You may also want to hang some acoustic foam on walls that are close to the monitors.

When positioning the monitors, you'll want to set up what is commonly referred to as the "mixing triangle". In this ideal configuration, the space between the left and right monitor is equal to the distance from the listener to each monitor, forming an equilateral triangle (as figure 1 shown).

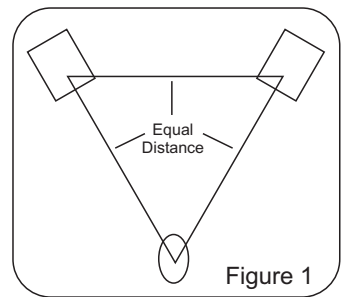

Figure 1

Setting up your PX-T G2 Active Studio Monitor System

Speaker Orientation

The PX-T G2's can be used in either the vertical or horizontal position. When using the monitors in the horizontal position, be certain to place the left and right side tweeters on the outer most sides. (As Figure 2 shown). This will improve the stereo imaging and bass response by increasing the coupling of the low-end drivers.

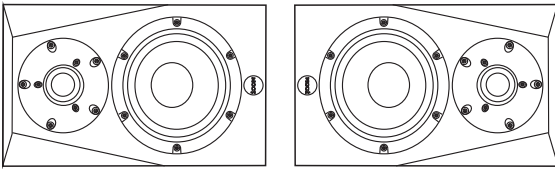
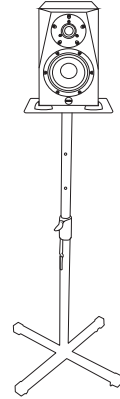

Figure 2



SB100X
ICON Studio Monitor Stand

Reflection

When choosing the height of your monitor system, be careful to avoid reflections off the surface of the mixing console (As Figure 3 shown). These reflections arrive at the listening position slightly delayed from the original sound resulting in strange cancellations and overall unpredictable response. Visualize straight lines representing the beams of sound radiating from the monitors and choose a height that reduces the occurrence of reflections that will end up in the prime listening spot (As Figure 4 shown). In most cases, the ideal position is slightly behind and above the mixing console's meter bridge.

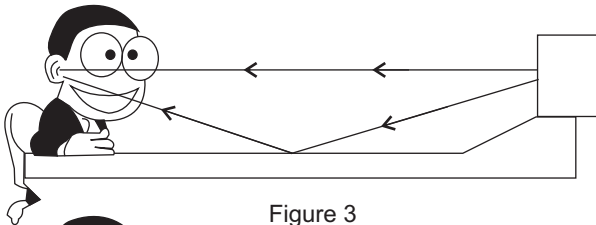

Figure 3

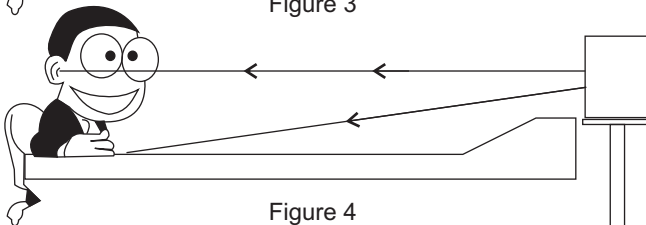

Figure 4

Connecting your PX-T G2 Active Studio Monitor system

PX-T G2 Quick Connections

Note: Before plugging in and turning on, remember the "last on, first off" rule of power amplifiers (and powered monitors). When powering up your system, be sure that all the wires are connected, turn your mixer and any other outboard gears on, and then last turn your PX-T G2 monitor on. When powering down, turn your PX-T G2 monitor off first and then your mixer and outboard gears.



The PX-T G2 connections can be made via one of the three-rear panel Audio inputs. You can use RCA inputs for unbalanced -10Bv level signals or the 1/4" TRS / XLR balanced +4dBu level signals input.

Follow the simple steps and diagram below for a quick connection using a standard recording console's (such as ICON's imix) control room outputs.

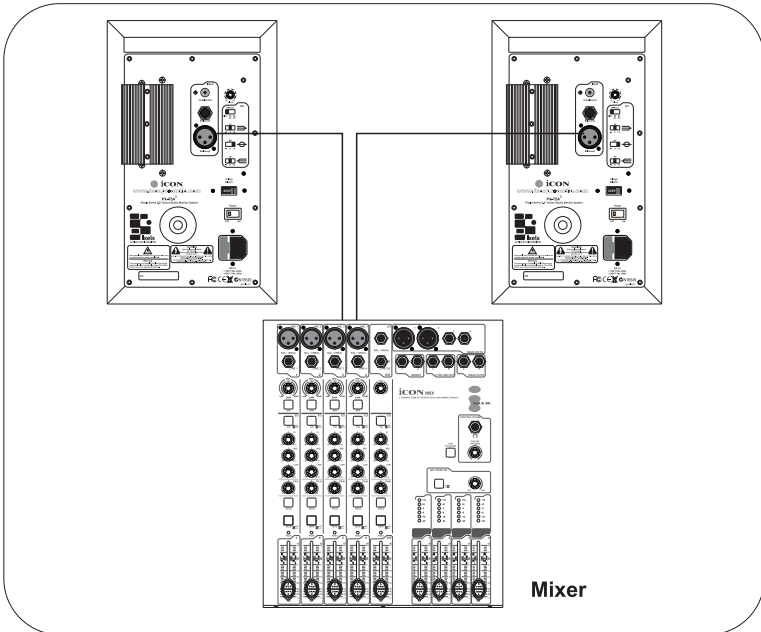

- Lower your mixer's master outputs to all the way down.
- Connect the mixer's left Control Room output to the left-side PX-T G2's Line input and the mixer's right Control Room output to the right-side PX-T G2's Line input.
- Set the PX-T G2's input volume control to the 2 o'clock position.
- Run an audio signal (like some music from a CD) through your mixer and raise the Control Room level to a comfortable listening level.

Operating your PX-T G2 Active Studio Monitor System

PX-T G2 Control & Connector Panels

The PX-T G2's rear panel is where you will make your connections for both AC power and audio signals. The rear panel also contains the controls to make adjustments to the overall volume and frequency response curve. The following section details the rear panel controls and connections.



Powering the PX-T G2 Active studio monitor system

Connect the unit to an AC power supply since the PX-T G2 is an active studio monitor with an on-board power amplifier. Make sure that the main power switch is set to the off position and connect the supplied IEC power cable into the AC inlet.

Things that go Hum!

When running power cables, be careful not to run the AC power cords or AC extension cords in parallel to your input cable. This will help reduce any AC hum that can be picked up. If you have to cross them at a 90 degree angle for the least amount of induced hum. Using the PX-T G2's balanced input connector will greatly protect against the induced hum thanks to the common mode rejection (the induced hum is phase cancelled) that is balanced input circuit provides.

- ① **Power switch**
Turn the unit on/off.
- ② **AC inlet**
Connect the supplied IEC power cable here.
- ③ **Hi-Pass Filter control**
Adjust the Hi-Pass filter from Flat, 60Hz and 80Hz.
- ④ **LF, MF & HF controls**
The PX-T G2's rear panel provides three important controls for adjusting the overall sound of the monitor's bass, midrange and treble. Adjust these controls to your preferable position. If you take your monitors to other studios you may find these controls extremely useful in adjusting the sound for the new room.

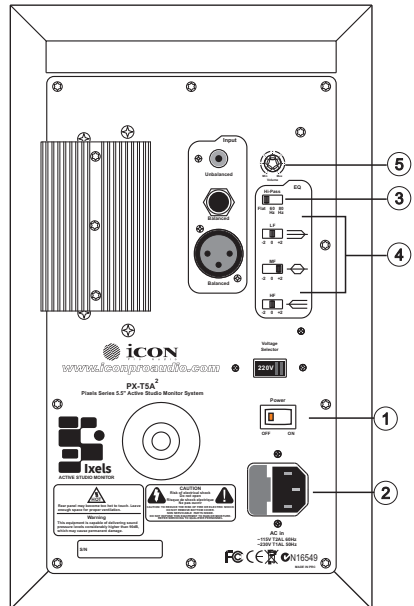

- ⑤ **Volume control**
The volume control is used to adjust the overall output level of the PX-T G2. When operating the unit for the first time, start with the volume control set all the way off. Slowly raise the volume control to reach a comfortable listening level.

Operating your PX-T G2 Active Studio Monitor System

The Rear Panel: The Ins and the Outs

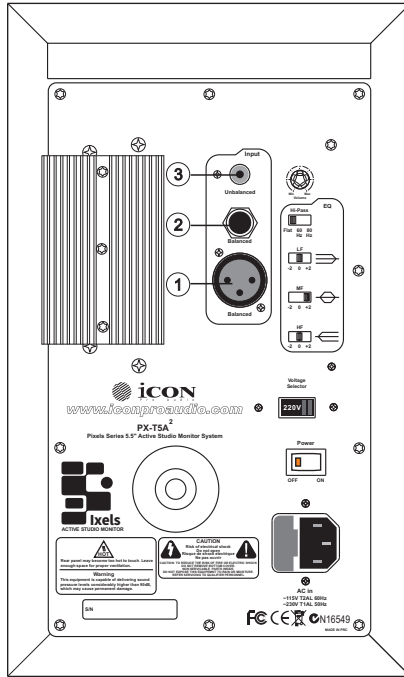

The PX-T G2 features a full complement of input connectors providing easy installation with a variety of audio devices like recording consoles, hard disk recorders, CD players and computer audio interfaces, to name a few. The following section details the PX-T G2's input connectors for audio signal and power.

① **Balanced XLR Audio Input**

The PX-T G2 features a female XLR connector that will accept balanced or unbalanced +4dBm line level signal. If you are using a mixer that has balanced output on XLR connector, you can make the connection via standard XLR cable.

② **Balanced 1/4" TRS Audio Input**

A balanced TRS (Tip, Ring, Sleeve) 1/4" plug is used to connect balanced or unbalanced line level signals. The 1/4" input is a switching jack, so when a 1/4" connector is inserted into the jack, the RCA and/or XLR inputs are switched off and the 1/4" input is switched on. This provides a convenient patch for quick insertion of a secondary signal source for testing or expanded operation.

③ **RCA Audio Input**

The RCA inputs accept unbalanced signal used to connect signals from unbalanced -10dBv devices.

Specifications

	PX-T5A²	PX-T6A²	PX-T8A²
System:	Two-way Active Nearfield monitor	Two-way Active Nearfield monitor	Two-way Active Nearfield monitor
Frequency response:	45Hz to 21 KHz	40Hz to 21 KHz	35Hz to 21 KHz
Input level for 85dB SPL @1m:	-14dBu RMS @ 0dB setting	-15dBu RMS @ 0dB setting	-15dBu RMS @ 0dB setting
Power consumption:	Idle: 10W / Max: 110W	Idle: 10W / Max: 140W	Idle: 10W / Max: 170W
Amplifier power:	HF:30W / LF:60W	HF:30W / LF:80W	HF:30W / LF:100W
Bass principle:	Bass reflex	Bass reflex	Bass reflex
Vent tuning frequency:	43Hz	40Hz	35Hz
Internal cabinet volume:	9 liters	15 liters	22 liters
Crossover frequency:	2.5KHz	2.2KHz	2.0KHz
Cross slope:	18dB/oct	18dB/oct	18dB/oct
Tweeter:	Esotec 25mm/1" silk dome plus heat sink and ferrofluid cooling	Esotec 25mm/1" silk dome plus heat sink and ferrofluid cooling	Esotec 25mm/1" silk dome plus heat sink and ferrofluid cooling
Woofer:	135mm/5.5" PPB cone with aluminum short circuiting ring and rigid cast aluminum basket	166mm/6.5" PPB cone with aluminum short circuiting ring and rigid cast aluminum basket	200mm/8" PPB cone with aluminum short circuiting ring and rigid cast aluminum basket
Weight:	7.5Kg (182 x 304 x 276)mm	11Kg (208 x 334 x 323)mm	14Kg (255 x376.2 x 290)mm
Dimensions (W x H x D):	(7.2 x 12x 10.9) inch	(8.2 x 13.1 x 12.8) inch	(10.0 x 14.9 x 11.4) inch

Services

If your PX-T needs servicing, follow these instructions.

Check our online Help Center at <http://support.iconproaudio.com/hc/en-us>, for information, knowledge, and downloads such as:

1. FAQ
2. Download
3. Learn More
4. Forum

Very often you will find solutions on these pages. If you don't find a solution, create a support ticket at our online Help Center at the link below, and our technical support team will assist you as soon as we can.

Navigate to <http://support.iconproaudio.com/hc/en-us> and then sign in to submit a ticket.

As soon as you have submitted an inquiry ticket, our support team will assist you to resolve the problem with your ICON ProAudio device as soon as possible.

To send defective products for service:

1. Ensure the problem is not related to operation error or external system devices.
2. Keep this owner's manual. We don't need it to repair the unit.
3. Pack the unit in its original packaging including end card and box. This is very important. If you have lost the packaging, please make sure you have packed the unit properly. ICON is not responsible for any damage that occurs due to non-factory packing.
4. Ship to the ICON tech support center or the local return authorization. See our service centers and distributor service points at the link below:

If you are located in US

Send the product to:

North America

Mixware, LLC –U.S. Distributor

11070 Fleetwood Street –Unit F.

Sun Valley, CA 91352; USA

Tel.: (818) 578 4030

Contact: www.mixware.net/help

If you are located in Europe

Send the product to:

Sound Service GmbH European

Headquarter Moriz-Seeler-Straße

3D-12489 Berlin

Telephone: +49 (0)30 707 130-0

Fax: +49 (0)30 707 130-189

E-Mail: info@sound-service.eu

If you are located in Hong Kong

Send the product to:

ASIA OFFICE:

Unit F, 15/F., Fu Cheung Centre,

No. 5-7 Wong Chuk Yueng

Street, Fotan, Sha Tin, N.T., Hong Kong.

5. For additional update information please visit our website at: www.iconproaudio.com.





<p>天猫官方旗舰店</p>  <p>天猫店iconproaudio旗舰店</p>	<p>抖音号</p>  <p>抖音iCON艾肯</p>	<p>哔哩哔哩</p>  <p>B站iCONProAudio</p>	<p>微信公众号</p>  <p>微信号iCON-PRO</p>	<p>官方售后QQ</p>  <p>4006311312.114.qq.com</p>
--	--	---	---	--

中国地区用户

<p>Twitter</p>  <p>www.twitter.com/iconproaudio</p>	<p>Instagram</p>  <p>www.instagram.com/iconproaudio</p>	<p>Facebook</p>  <p>www.facebook.com/iconproaudio</p>	<p>Youtube</p>  <p>www.youtube.com/iconproaudio</p>
--	--	---	--

<p>Website</p>  <p>www.iconproaudio.com</p>	<p>Support</p>  <p>support.iconproaudio.com</p>	<p>Dashboard</p>  <p>iconproaudio.com/dashboard/</p>
---	---	---

www.iconproaudio.com